

MODEL: *B610-18-SF*

Size

Projection 6-5/8"
Height 10"

Length:

-Overall 20"
-Anchor Holes 18"
-Rubber 14"
Angle Size (2) 1/4"x3"x4"x9-1/2"
Slot Angle Size 1/4"x3"x4"x9-1/2"
Face Plate Size (1) 3/8"x10"x14"

Bolt Heads Are Inscribed
"DURABLE CORP"

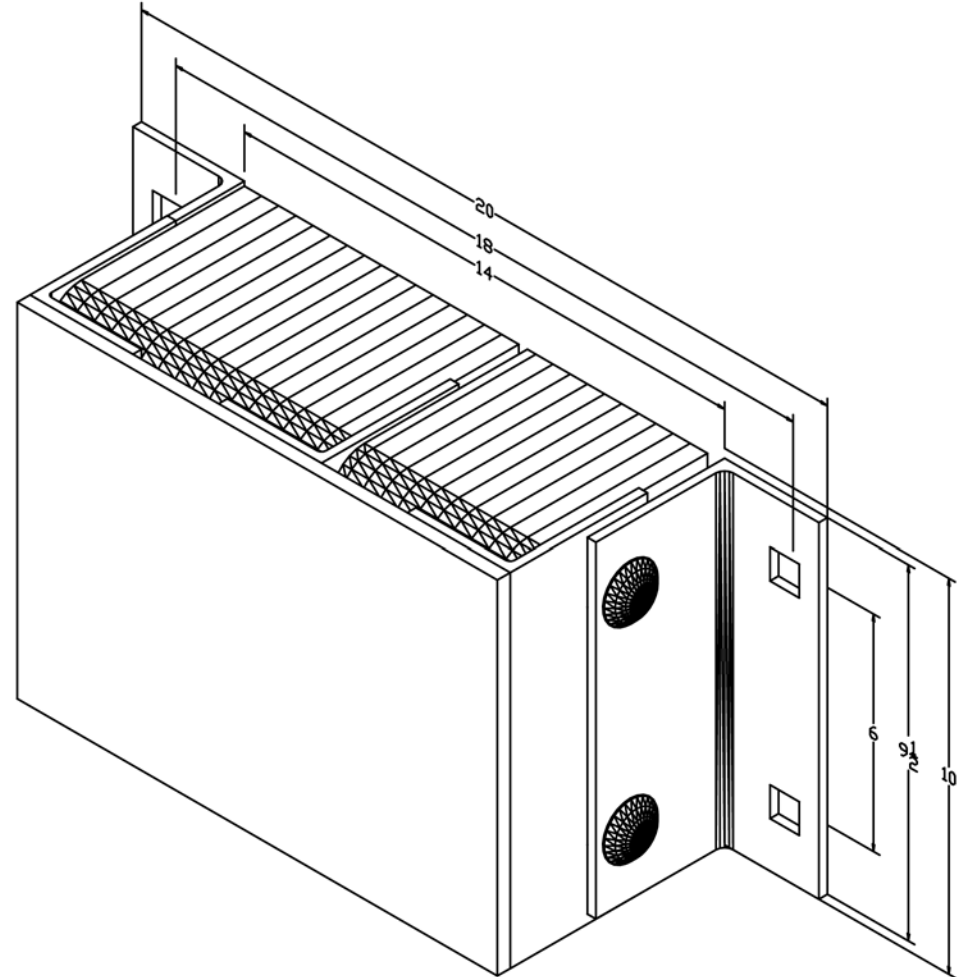

All measurements are +/- 1/8"