

MODEL: *B612-111-A*

Size

Projection

6"

Height

12"

Length:

-Overall

113"

-Anchor Holes

111"

-Rubber

107"

Angle Size (2)

1/4"x3"x4"x11-1/2"

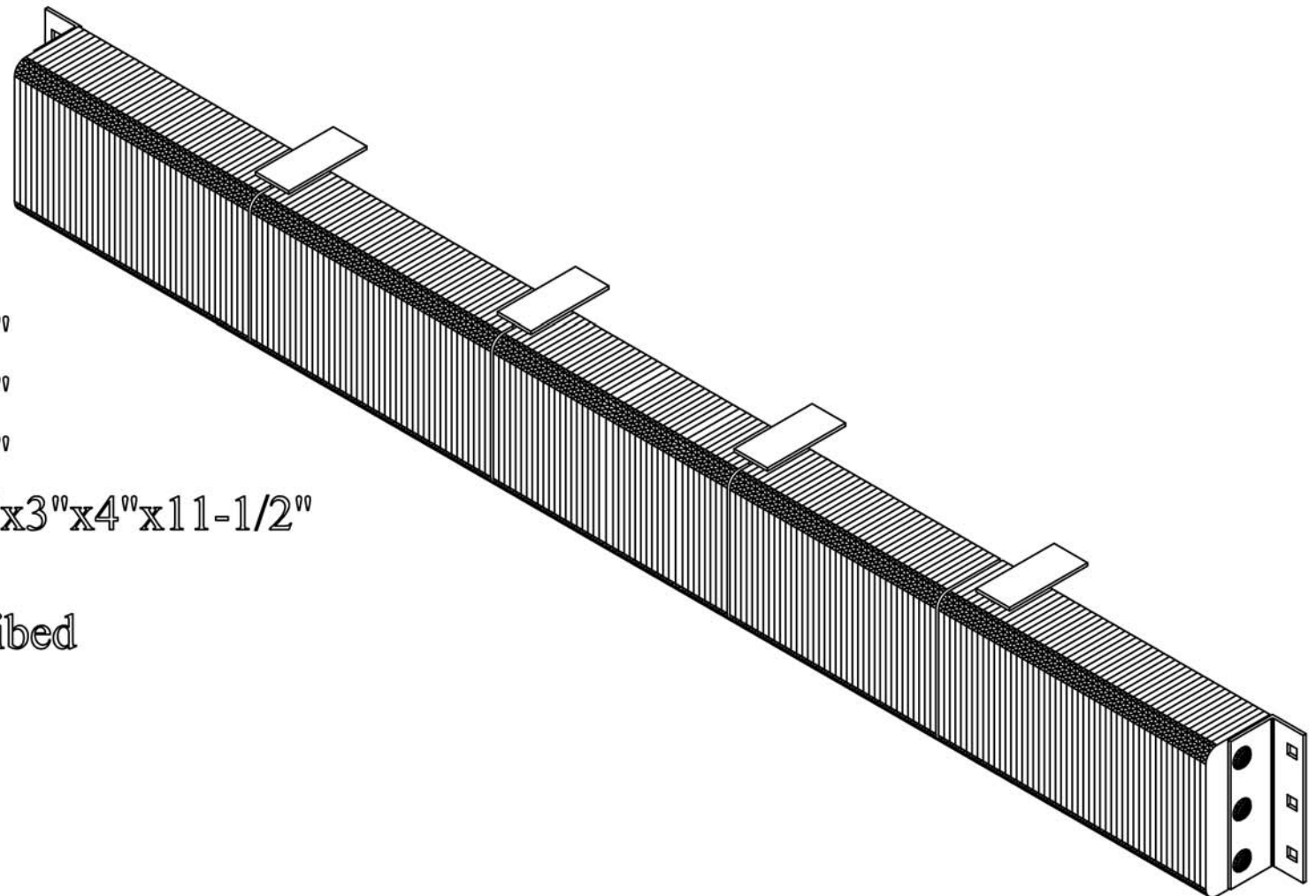

Bolt Heads Are Inscribed
"DURABLE CORP"

All measurements are +/- 1/8"

Laminated Dock Bumpers

B612-111-A

6" X 12" X 111"

WWW.LOADINGDOCKSUPPLY.COM

Features

Tough plies of truck tire material virtually eliminates chipping or abrasion, unlike molded rubber, extruded rubber, conveyor belting or wood plank bumpers. Attractive deep black color enhances a neat, professional architectural look. Manufactured under pressure exceeding 1,500 lbs. to absorb over 80% of impact force. Anchor bolts are protected by at least 3" of rubber to prevent damage.

Material/Thickness

Fabric reinforced rubber pads cut from selected recycled truck tires. Rubber pads laminated between structural steel angles and secured with 3/4" steel tie rods.

Installation

Structural mounting angles permit welded installations or provide bolting through steel

Extra Length bumpers must be supported in the center. You will need to specify one of these anchorage devices when placing your order.

Bumpers may be ordered with angles or flat plates at each end. Use a flat plate for mounting bumper next to a dock leveler, or where the space is too tight to allow the use of angles. Note: When using the flat plate, it is welded to the dock.

