

MODEL: *B612-18-P2*

Size

Projection 6"
Height 12"

Length:

-Overall 14-1/2"
-Rubber 14"
Plate Size (2) 1/4"x4"x11-1/2"

Bolt Heads Are Inscribed
"DURABLE CORP"

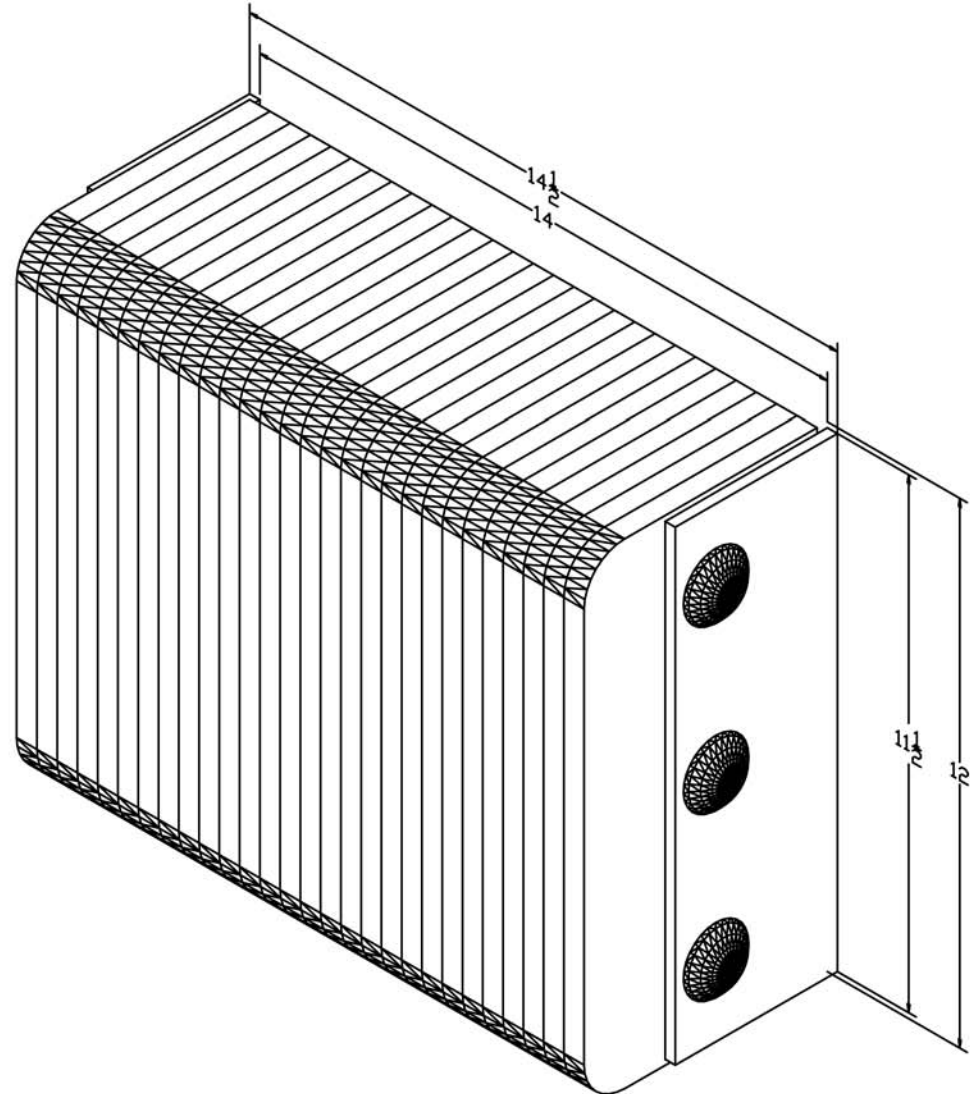

All measurements are +/- 1/8"