

MODEL: *B612-87-A*

Size

Projection 6"  
Height 12"

Length:

-Overall 89"  
-Anchor Holes 87"  
-Rubber 83"  
Angle Size (2) 1/4"x3"x4"x11-1/2"

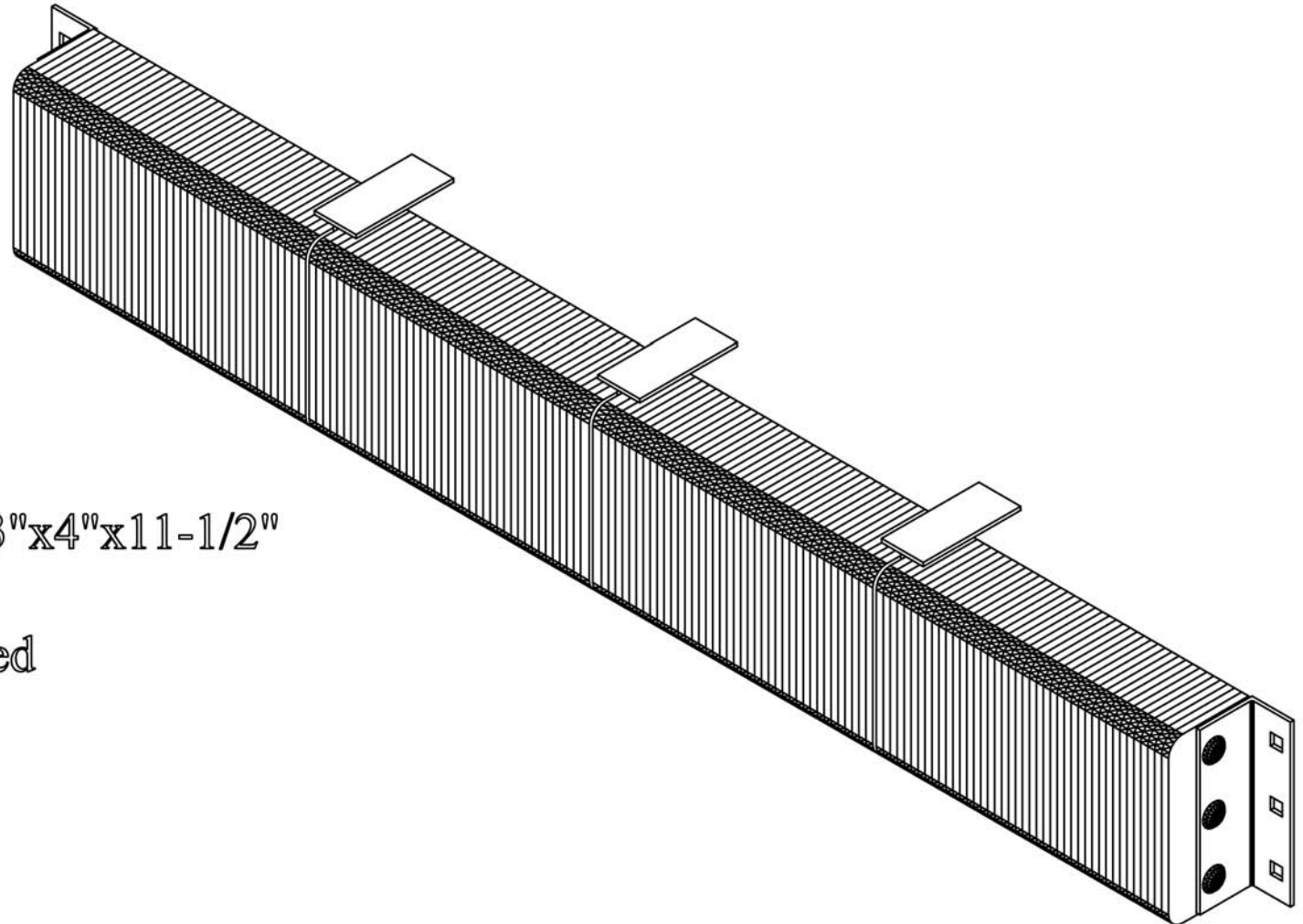

Bolt Heads Are Inscribed  
"DURABLE CORP"

All measurements are +/- 1/8"

# Laminated Dock Bumpers

## B612-87-A

6" X 12" X 87"

WWW.LOADINGDOCKSUPPLY.COM

### Features

Tough plies of truck tire material virtually eliminates chipping or abrasion, unlike molded rubber, extruded rubber, conveyor belting or wood plank bumpers. Attractive deep black color enhances a neat, professional architectural look. Manufactured under pressure exceeding 1,500 lbs. to absorb over 80% of impact force. Anchor bolts are protected by at least 3" of rubber to prevent damage.

### Material/Thickness

Fabric reinforced rubber pads cut from selected recycled truck tires. Rubber pads laminated between structural steel angles and secured with 3/4" steel tie rods.

### Installation

Structural mounting angles permit welded installations or provide bolting through steel

**Extra Length bumpers must be supported in the center. You will need to specify one of these anchorage devices when placing your order.**

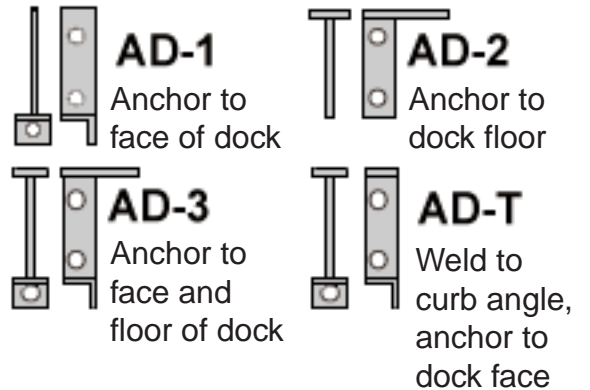
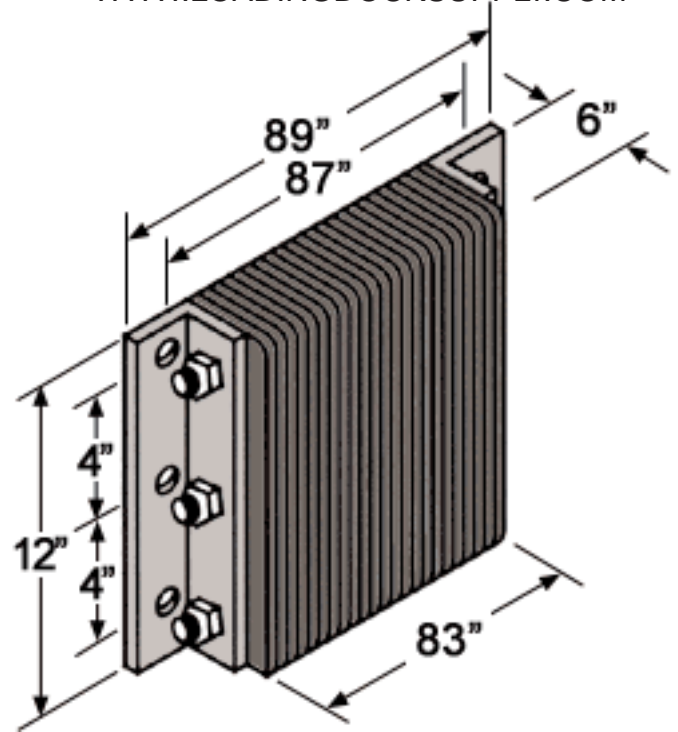

Bumpers may be ordered with angles or flat plates at each end. Use a flat plate for mounting bumper next to a dock leveler, or where the space is too tight to allow the use of angles. Note: When using the flat plate, it is welded to the dock.

